

# Back Bay Complex

Backbay 2

Backbay 1

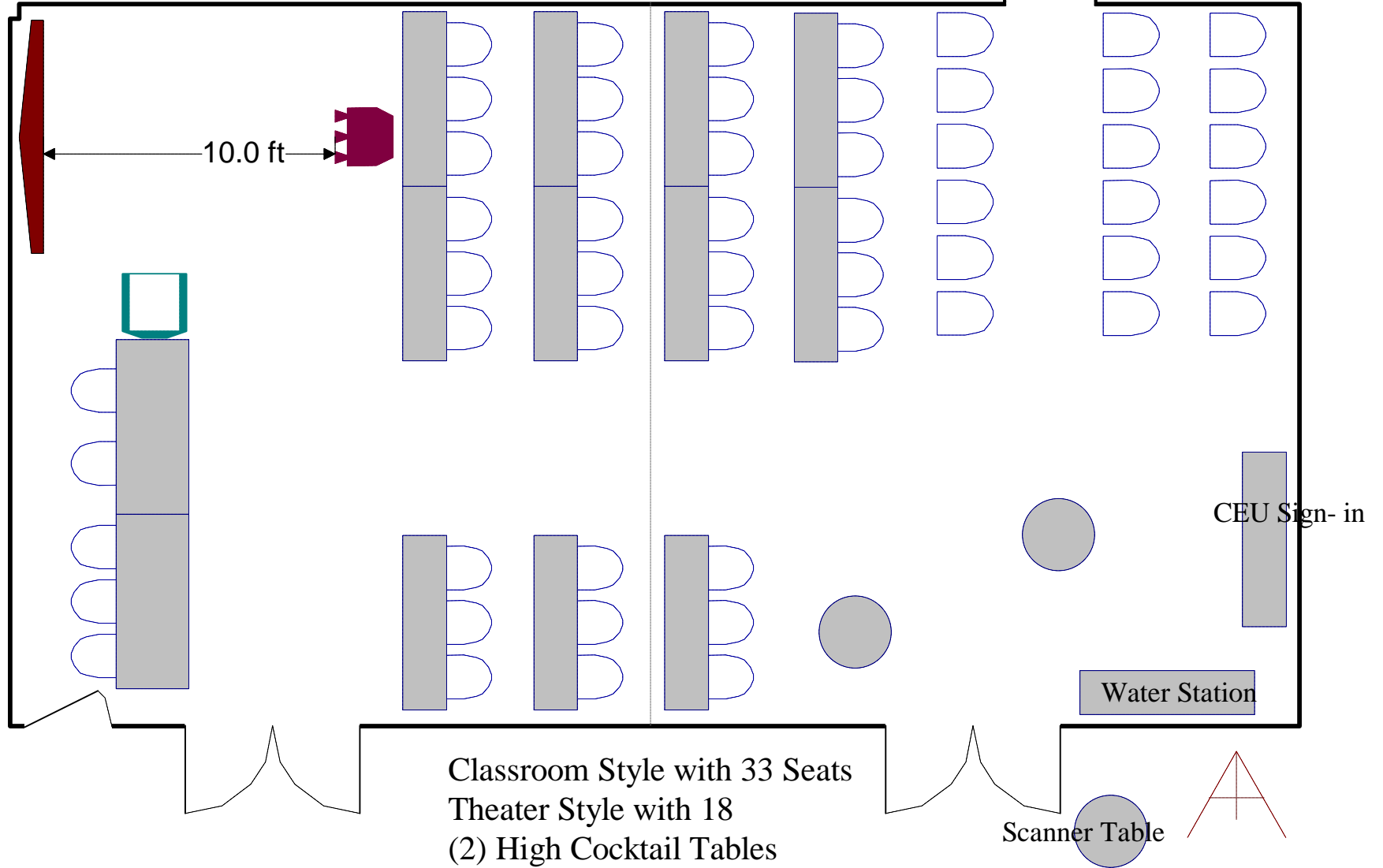

Classroom Style with 33 Seats  
Theater Style with 18  
(2) High Cocktail Tables

Scanner Table

CEU Sign- in

Water Station



# Beacon Hill

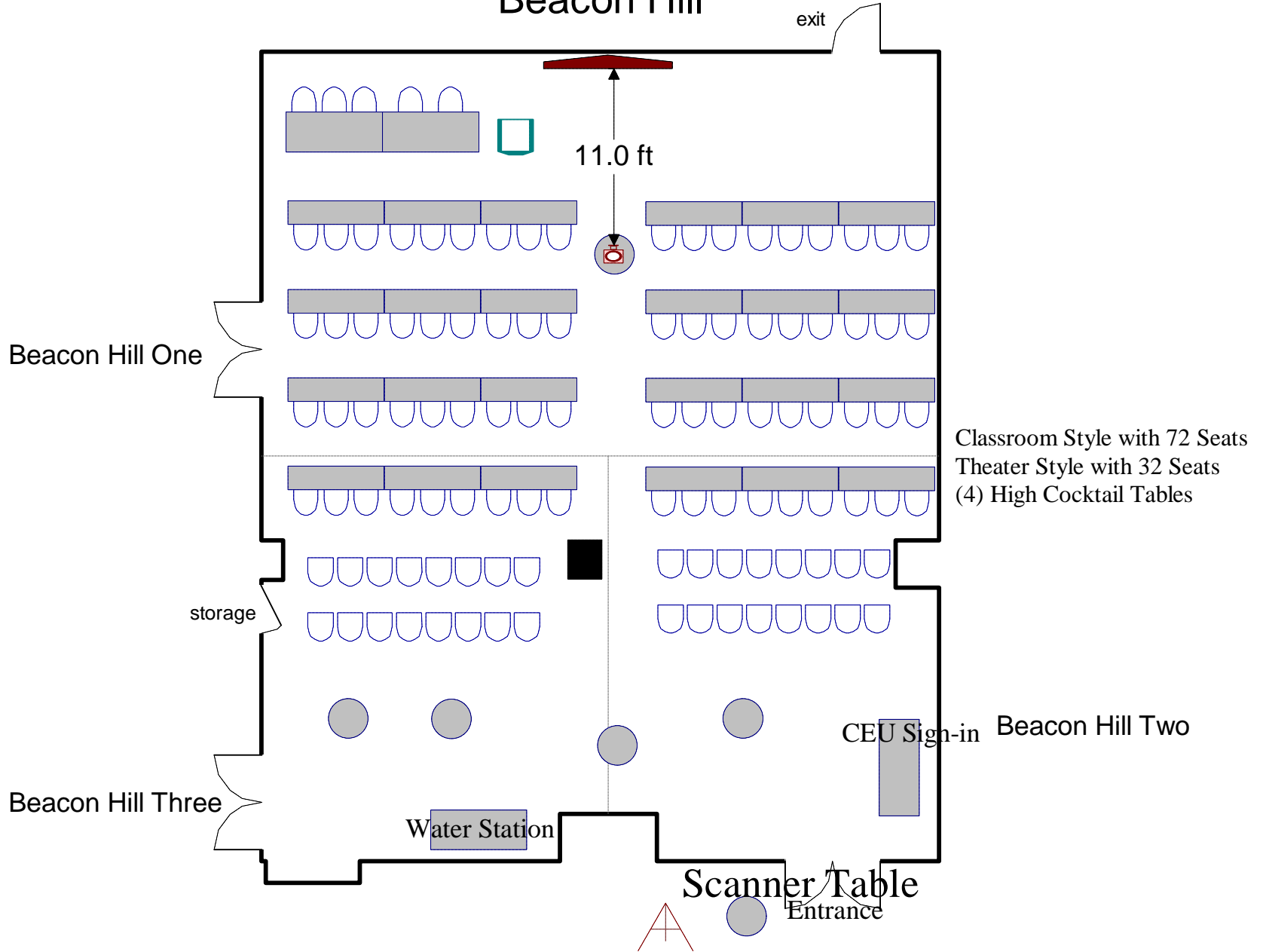



Classroom Style with 36 Seats  
Theater with 34 Seats

Cambridge Two

Cambridge One

(R)

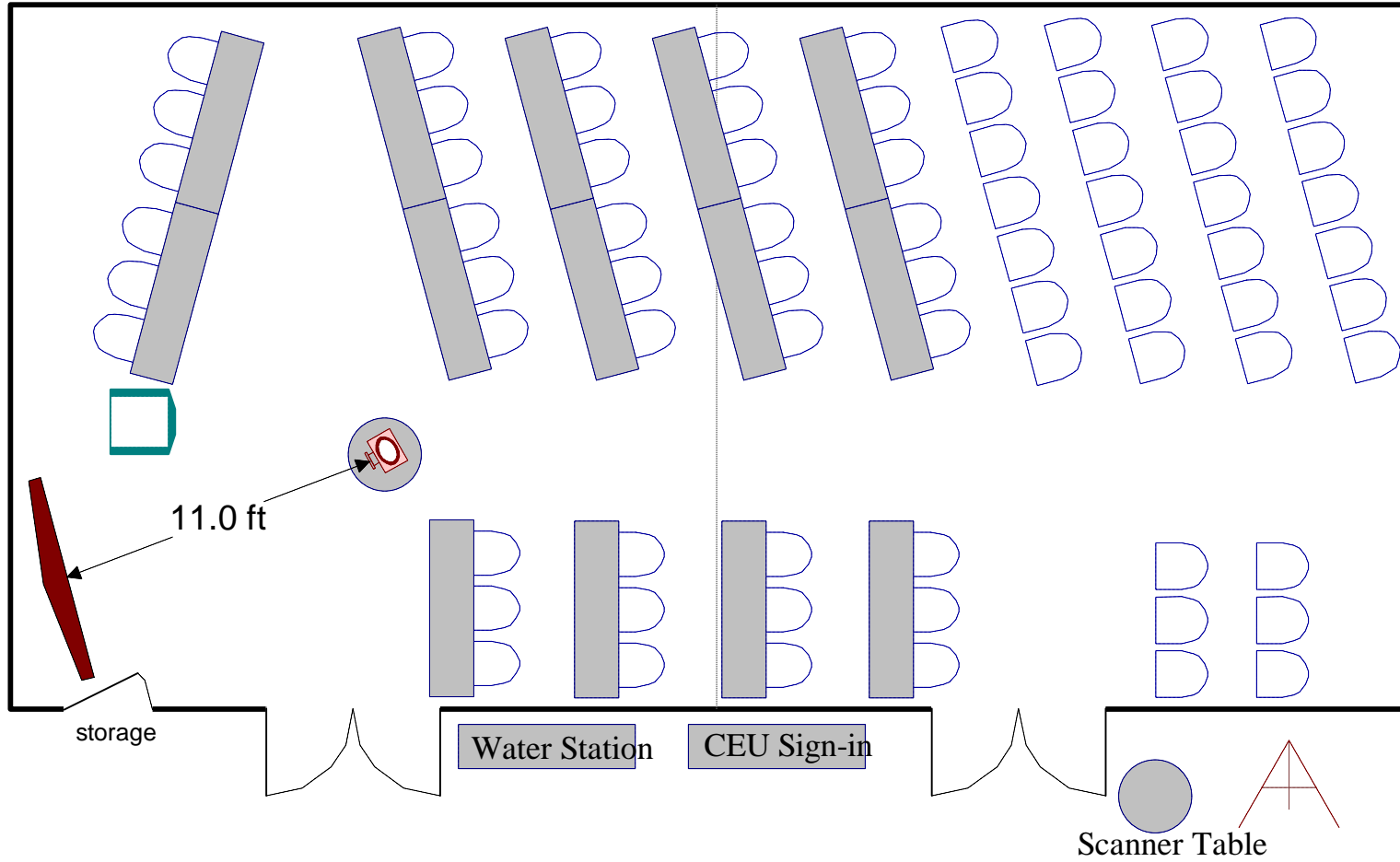



# Cityview Ballroom

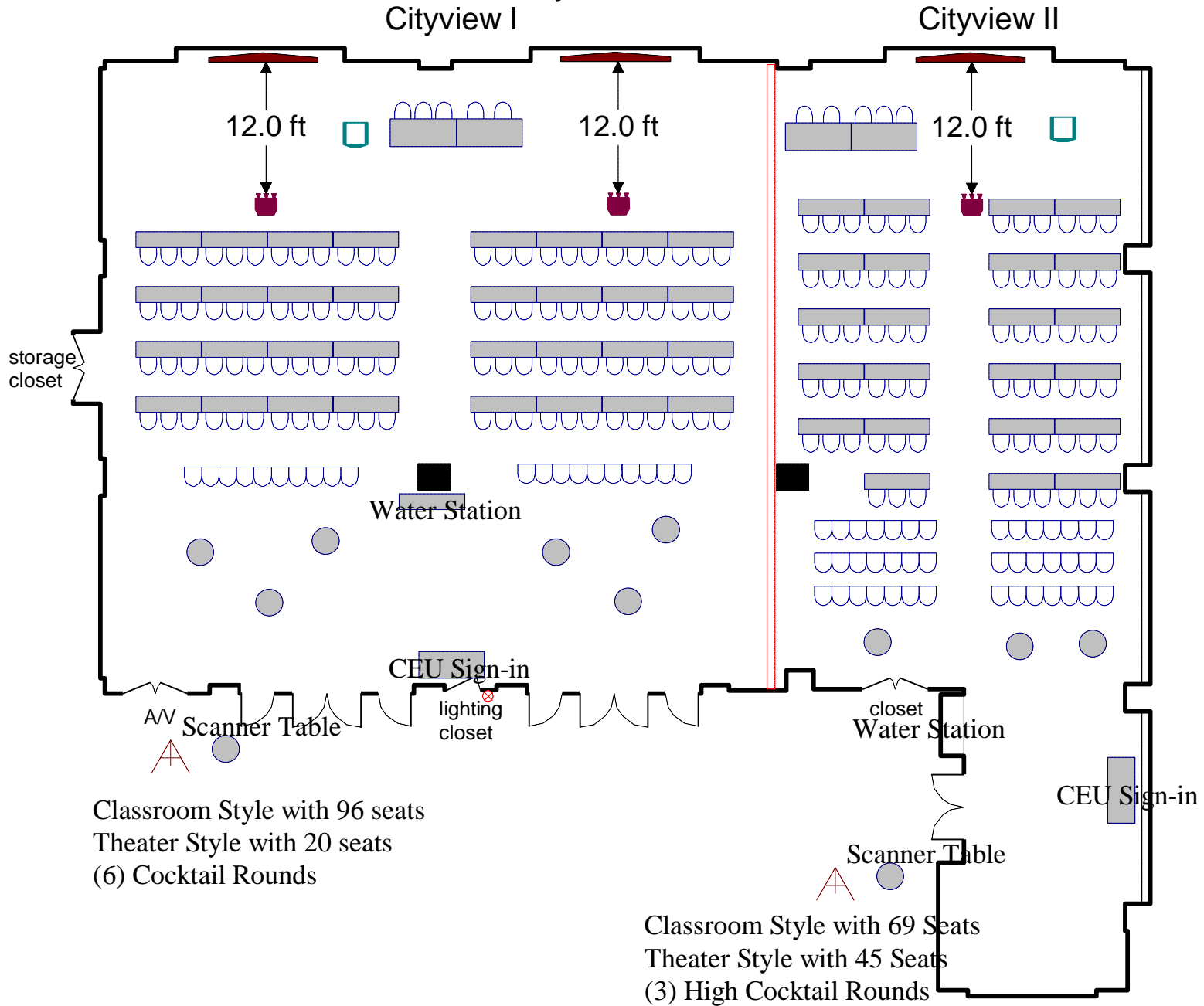

# Federal Complex

Federal A

Federal B

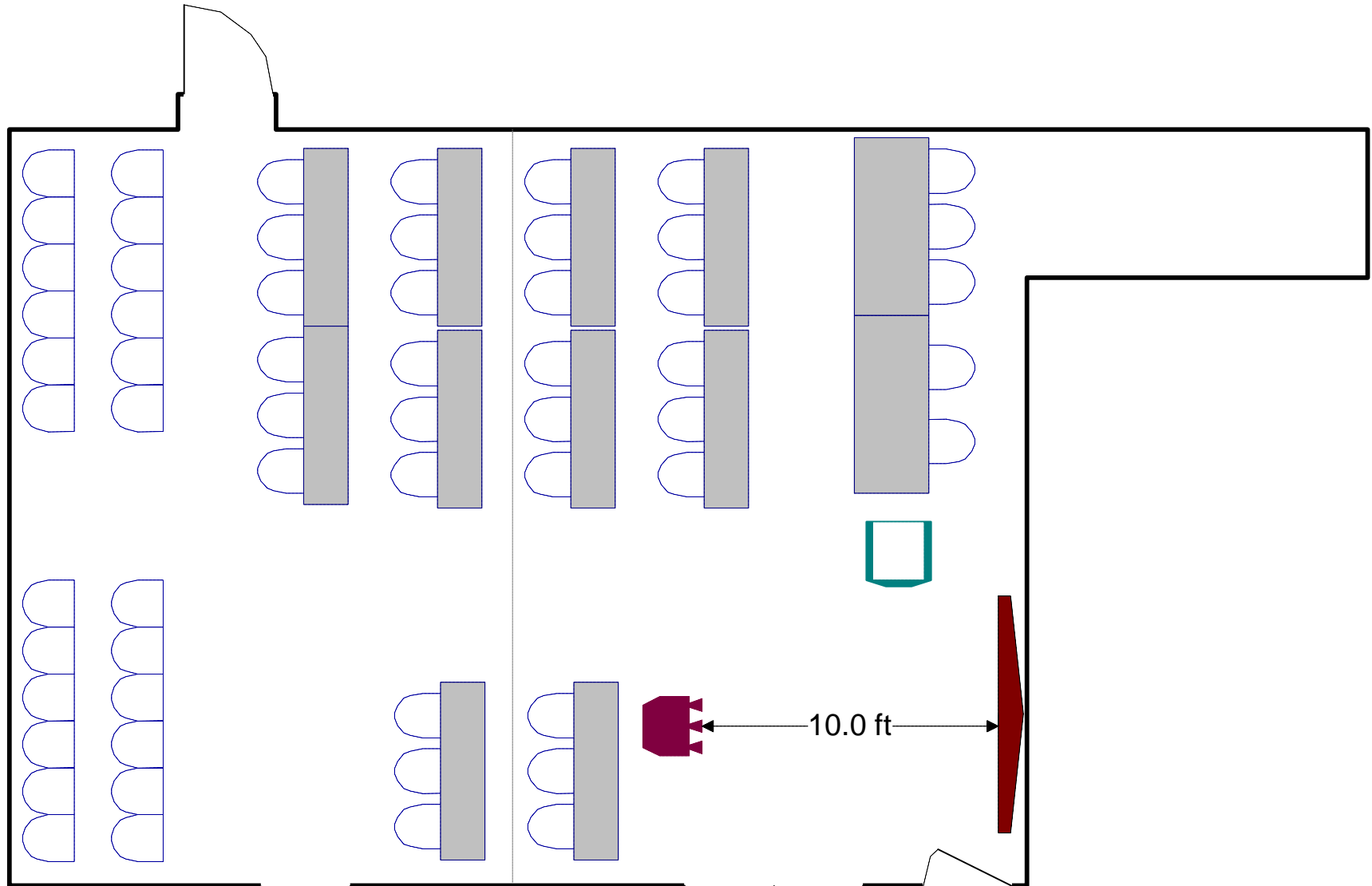

CEU Sign in

Water Station

Scanner Table

Classroom Style with 30 seats  
Theater Style with 24 seats

10.0 ft

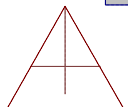

# Harborview Ballroom

Theater Style with 516 Seats

Harborview III

Harborview II

Harborview I

Deck

Deck

Deck

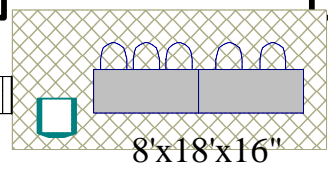

8'x18'x16"

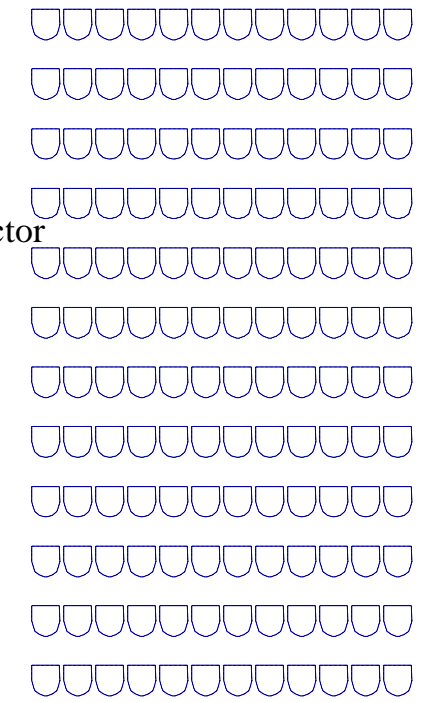
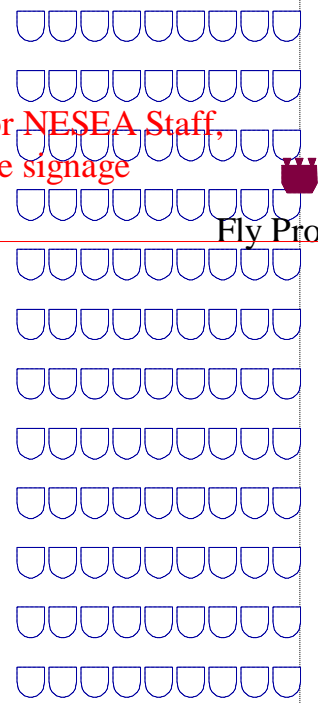
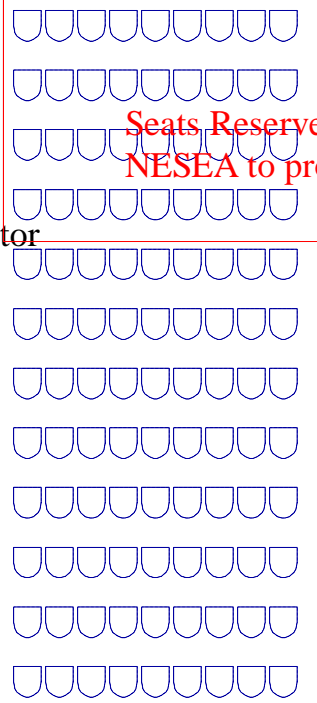
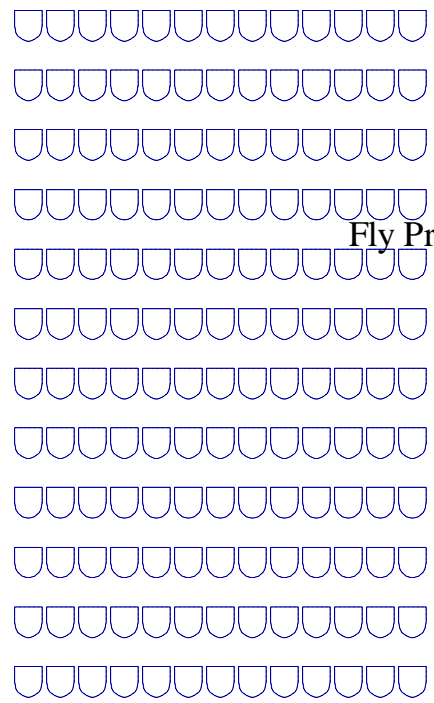

Seats Reserved for NESEA Staff,  
NESEA to provide signage

Fly Projector

Fly Projector

exit

staff



Water Station

CEU Table

Tech

Scanner Table



(4) Counter Height Glass Tables

# Waterfront Ballroom

